

JAKUBOVA HŮL

- Jakubova hůl (popis a historie)
- poziční úhel
- praktické měření (s holí i bez)

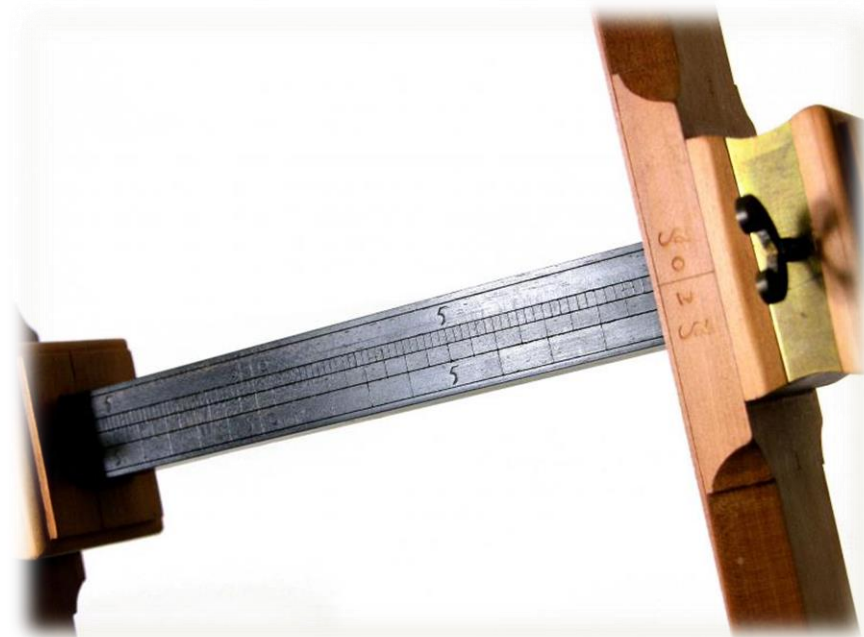

- určování polohy (úhlová výška nad obzorem) a tím zeměpisné šířky.
- k navigaci (zejména na moři)
- vytyčování úhlů

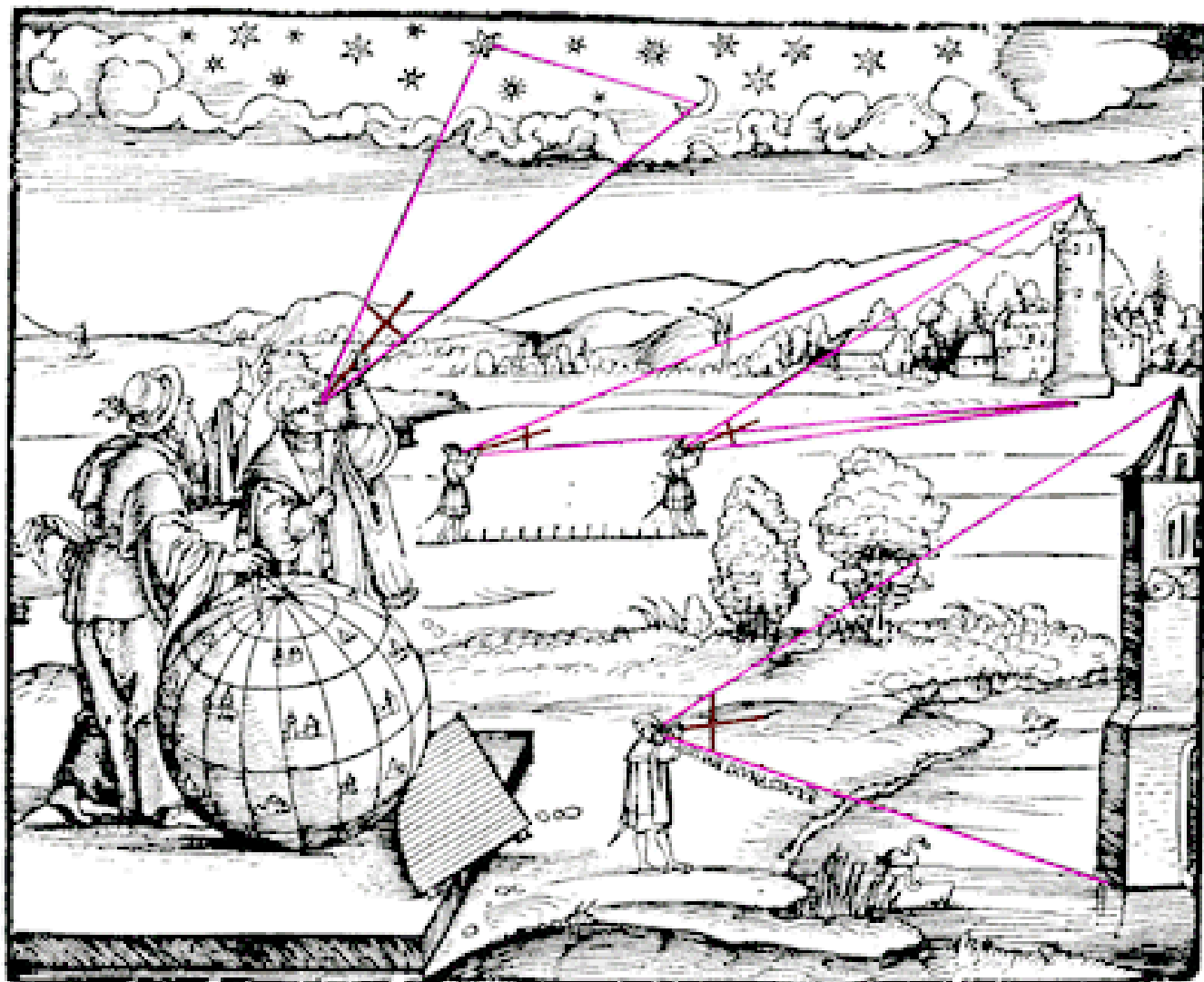

- křížová hůl (crossstaff)
- ballastella
- ballestilha

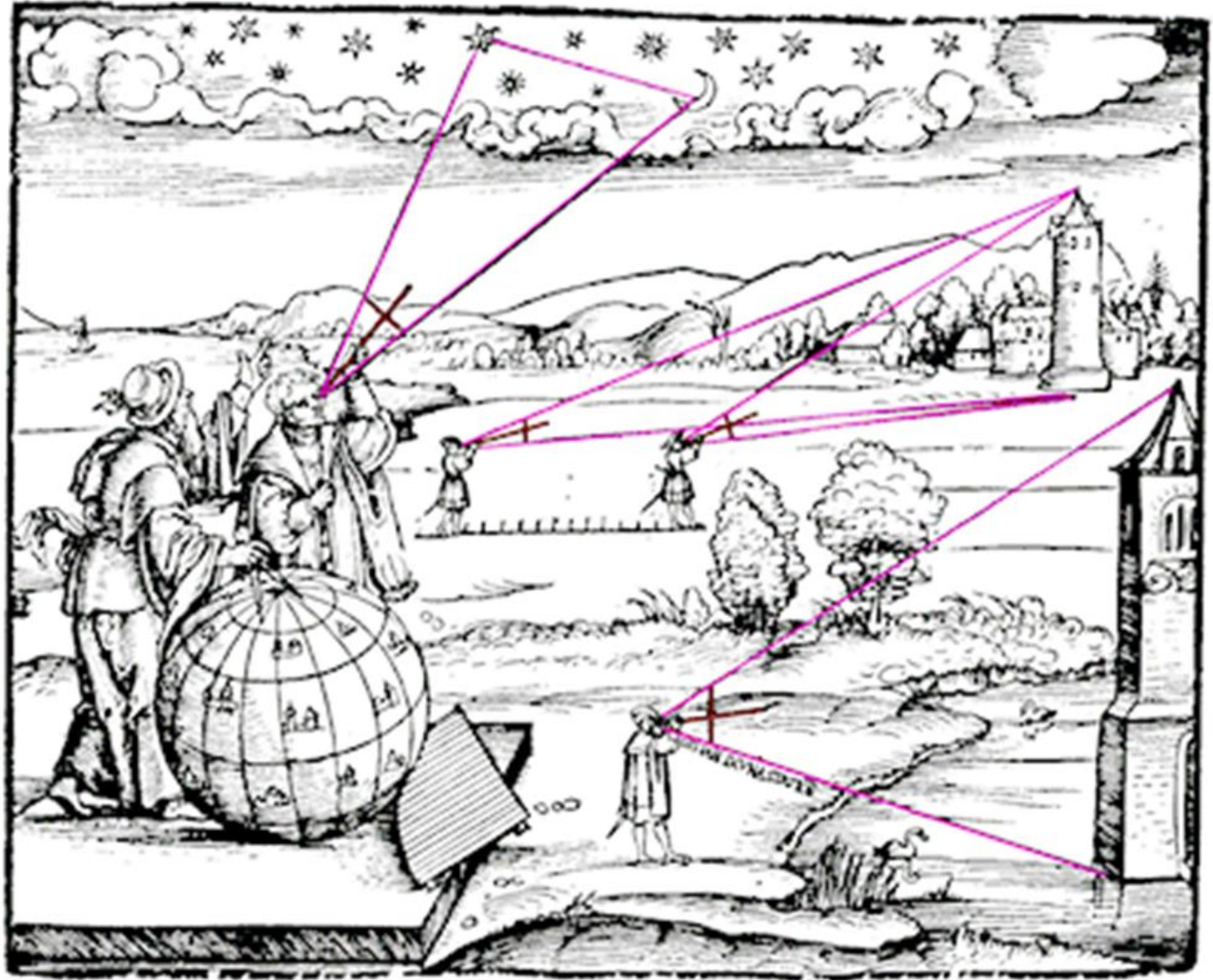

- podélná tyč AB s měřítkem
- souměrný běhoun CC' délky b , který je posuvný po podélné tyči

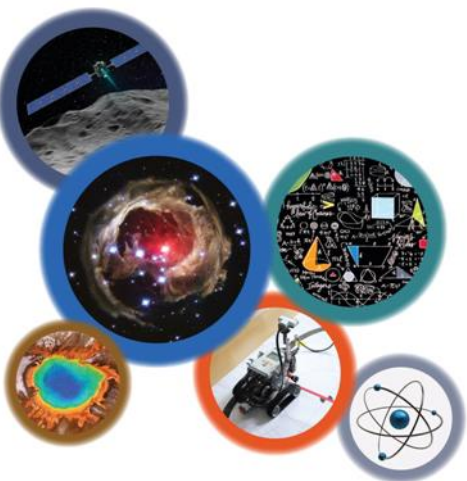
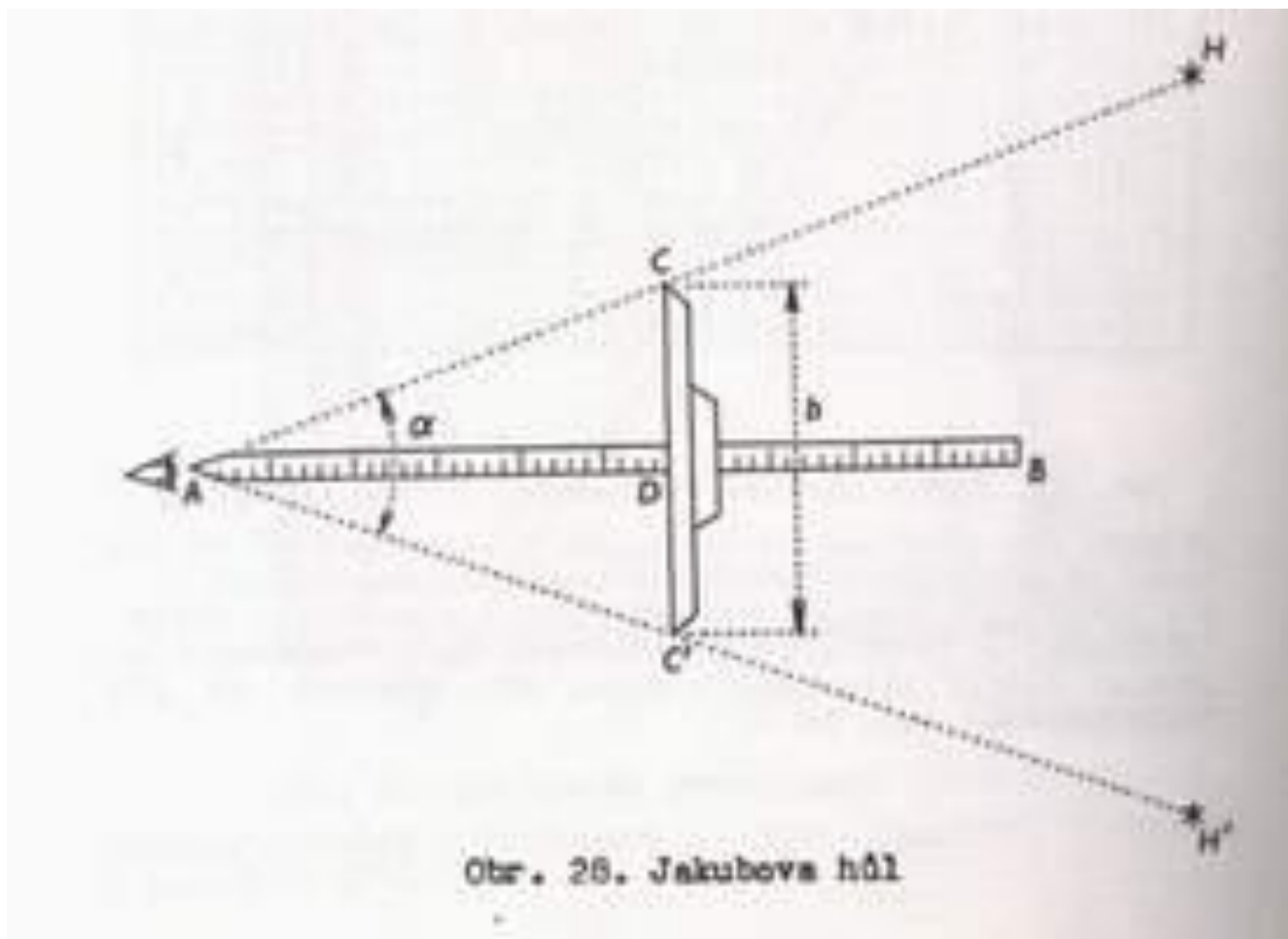

Při měření úhlu (α) mezi hvězdami H, H' drží pozorovatel jednou rukou tyč AB a druhou posunuje běhounem CC' dokud oko přiložené k bodu A vidí koncové body C, C' ve splývání s hvězdami H, H'.

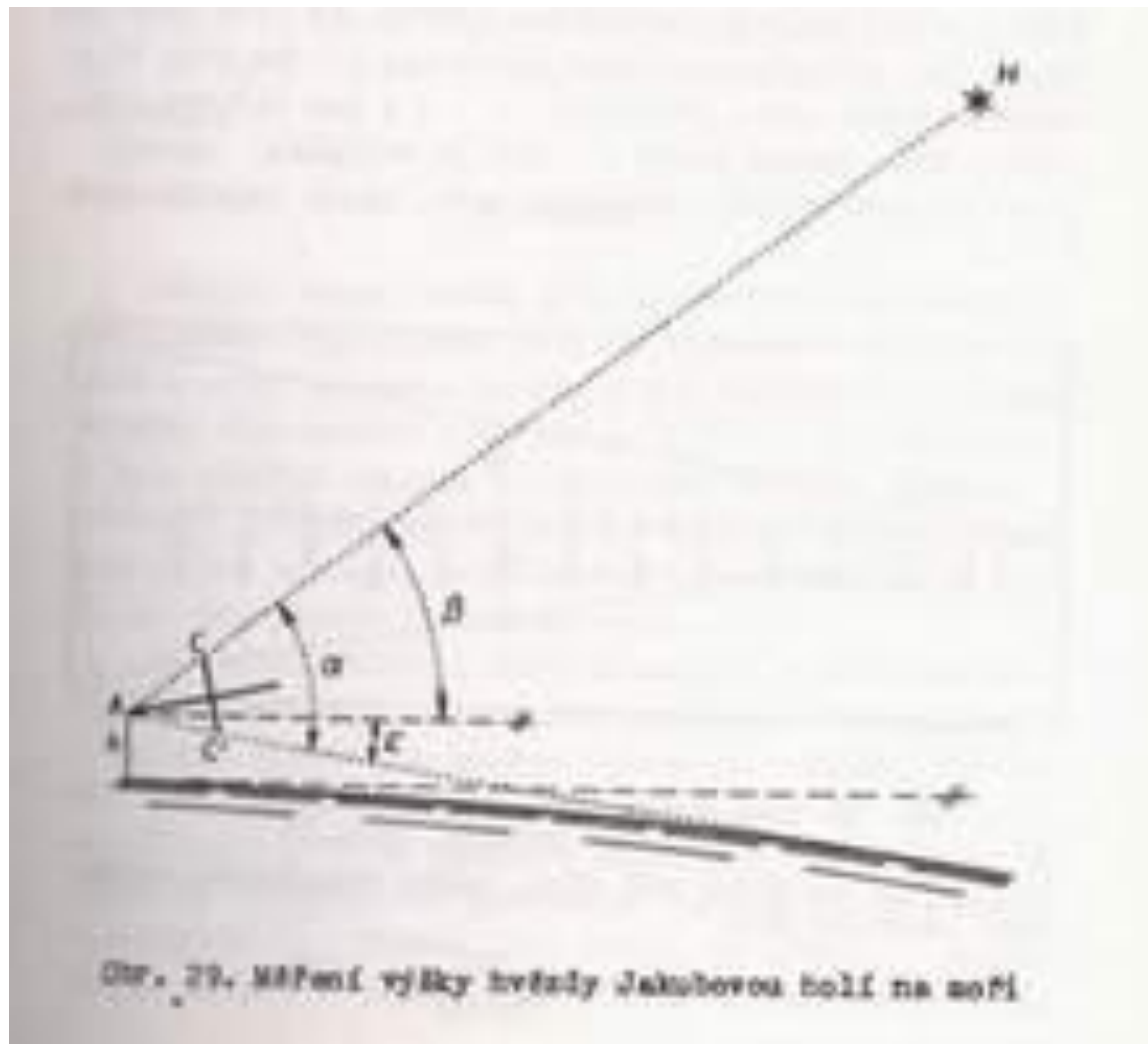

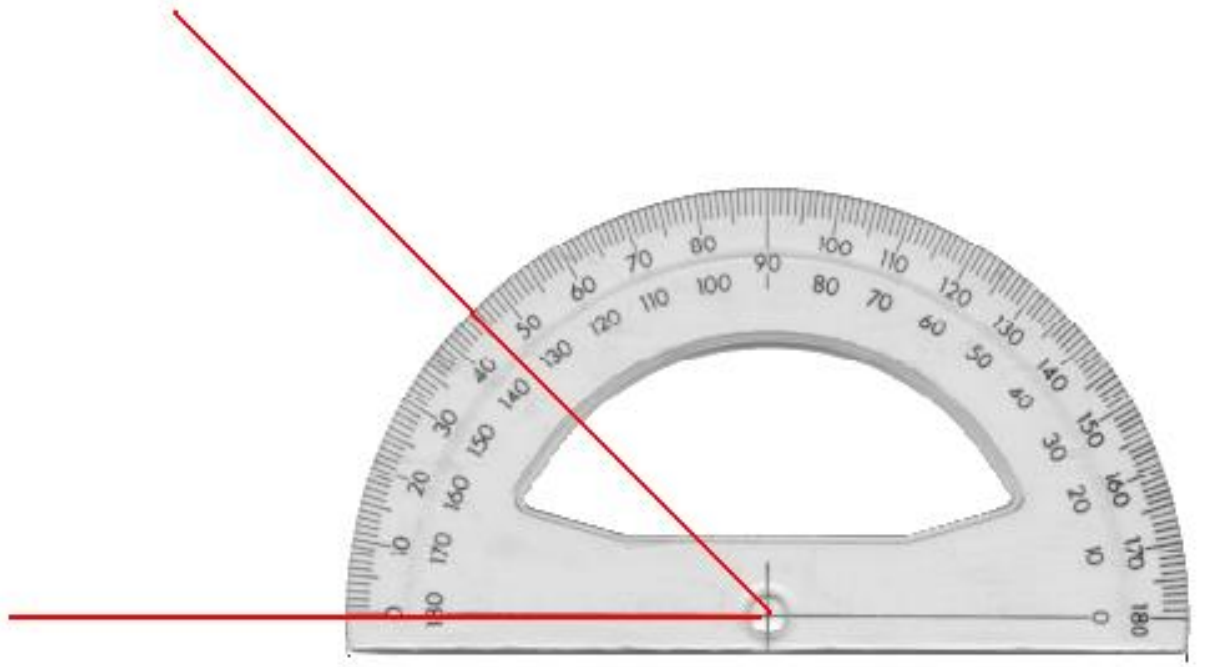
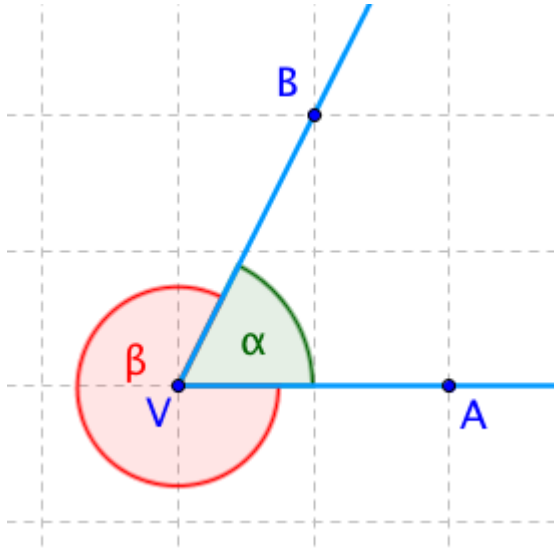

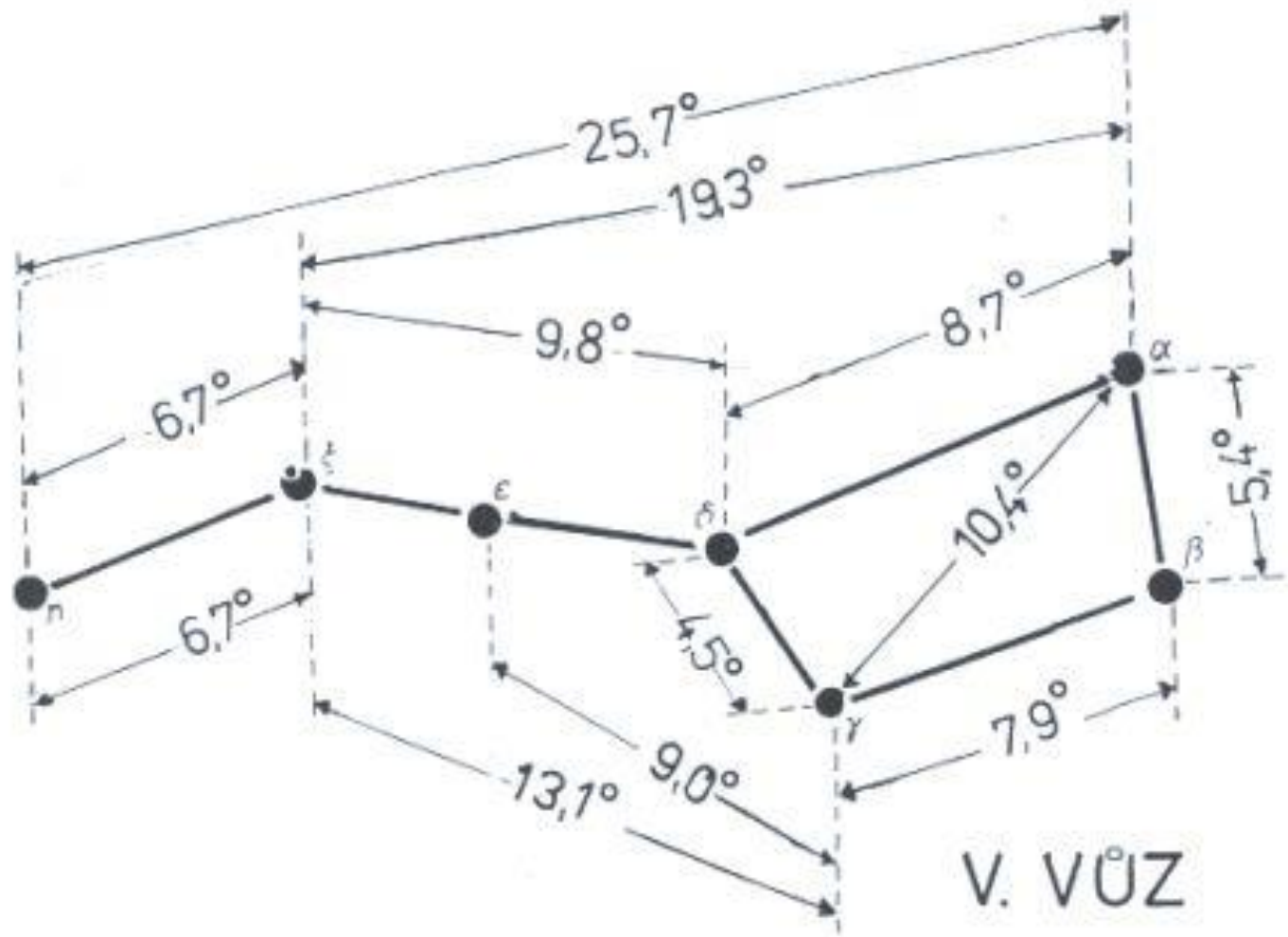

V. VÜZ



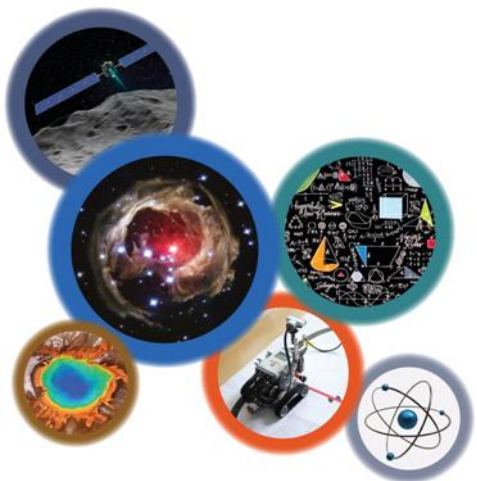
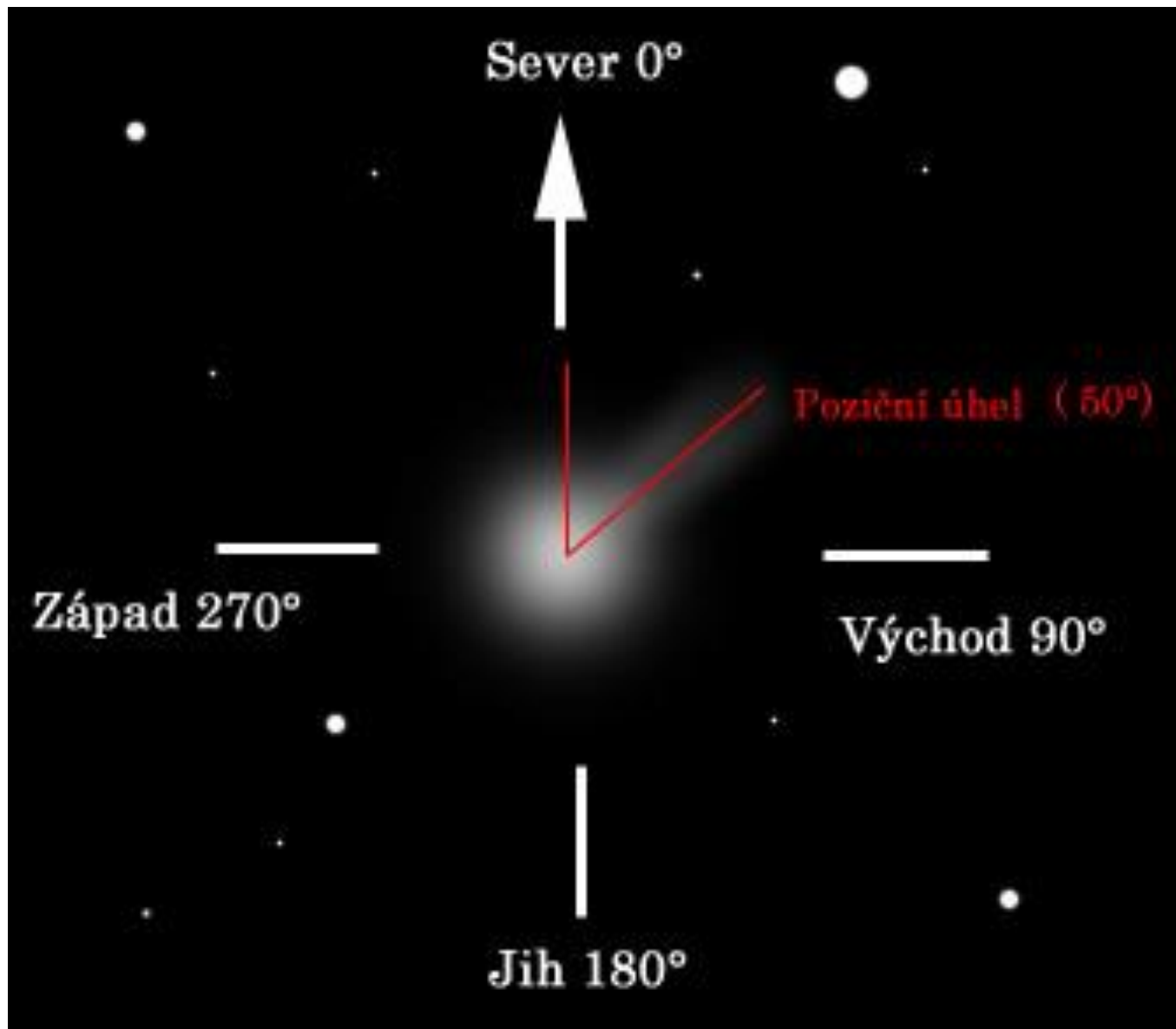

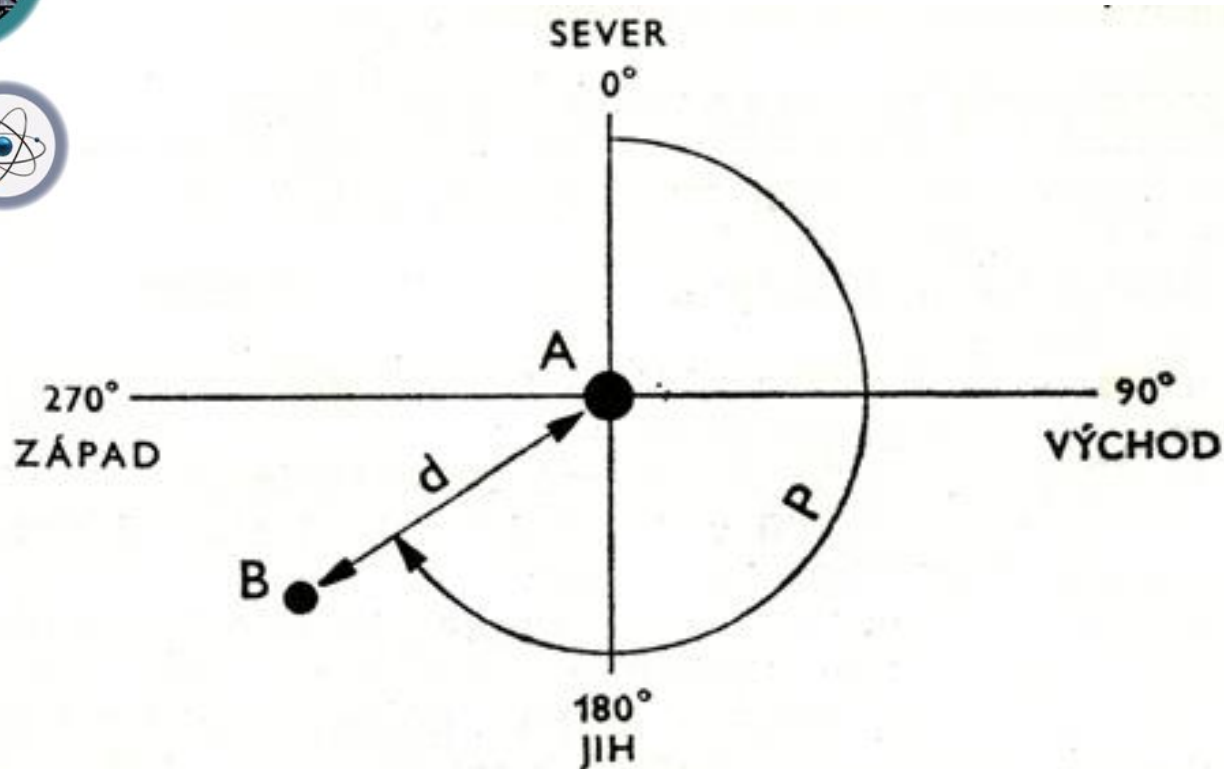

Poziční úhel, úhel, který svírá měřený směr s deklinační kružnicí. Měří se od S (0°) přes V (90°), J (180°) a Z (270°).

Kroužek pro přírodovědné talenty při Hvězdárně Valašské Meziříčí

